

NKXR35-XL

Needle roller/axial cylindrical roller bearing

Schaeffler ID:
0507807780000

Needle roller/axial cylindrical roller bearings NKXR, axial component, single direction, to DIN 5429, without end cap, for oil lubrication

X-life

Technical information

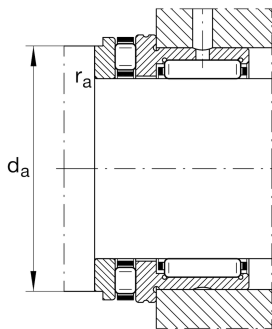
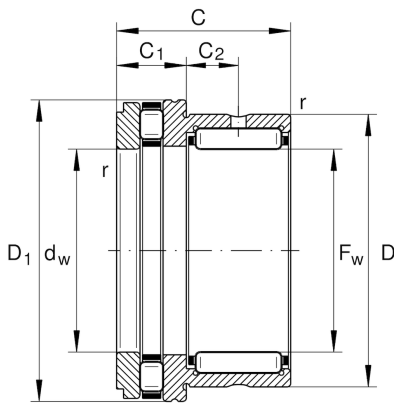

Main Dimensions & Performance Data

F_w	35 mm	Bore diameter
D	47 mm	Outside diameter
C	30 mm	Height
C_r	27,500 N	Basic dynamic load rating, radial
C_{0r}	41,500 N	Basic static load rating, radial
C_a	39,000 N	Basic dynamic load rating, axial
C_{0a}	101,000 N	Basic static load rating, axial
C_{ur}	7,400 N	Fatigue load limit, radial
C_{ua}	9,600 N	Fatigue load limit, axial
n_G	6,500 1/min	Limiting speed
$n_{\vartheta r}$	2,500 1/min	Reference speed
	154.93 g	Weight

Dimensions

$D_{1\max}$	52.1 mm	Maximum outside diameter flange
	IR30X35X20-XL	Suitable inner rings IR
$D_{2\max}$	52.1 mm	Maximum outside diameter flange
C_1	12 mm	Width of the axial bearing component
C_2	9 mm	Distance to lubrication hole
d_w	35 mm	Bore diameter of shaft washer
r_{\min}	0.6 mm	Minimum chamfer dimension

Mounting dimensions

d_a	47.7 mm	Mounting dimension shaft shoulder
$r_{a\max}$	0.6 mm	Maximum recess radius

Temperature range

T_{\min}	-30 °C	Operating temperature min.
T_{\max}	120 °C	Operating temperature max.